

**※ Please read carefully the following considerations to avoid the potential damage during installation.**

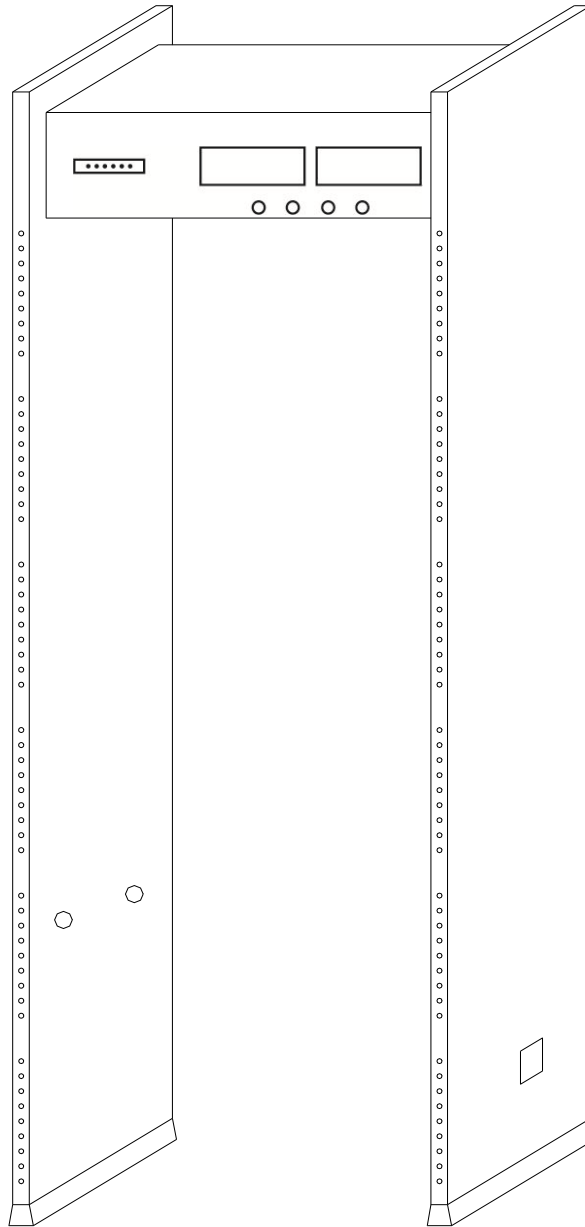

1. It's available for indoor use, if using outdoors, must be protected by waterproof canopy.
2. Choose the smooth and stable installation place, don't touch the detector during security checking to avoid false alarm.
3. Make sure there's no big metal object or strong magnetic field around the detector within 1~2 meters.
4. Detector probe mustn't install in high temperature or wet circumstance.
5. Please wait 1 minute for its self-diagnosing when machine starts.
6. Do not disassemble the control units except for the professional technician.
7. Follow the user manual carefully and make sure the right wire connection before starting.

## 【INTRODUCTION】



Walk Through Metal Detector is mainly used for routine security checking. When the passengers carry metal content over preset parameters value, the detector will automatically alarm, meanwhile side LED lights will accurately indicate the alarm location. It greatly helps security guards faster and easier to find out the prohibited metal objects, such as guns, knives, keys...etc.

## 【INSTALLATION GUIDE】

### 1. Stationary Metallic objects

When installing walk through metal detector, it should stay away from the stationary or fixed bulk metal items at least 30cm; otherwise it will affect the sensitivity, causing false alarm. Metal items include aluminum alloy / stainless steel doors and windows, with reinforced wall, etc.

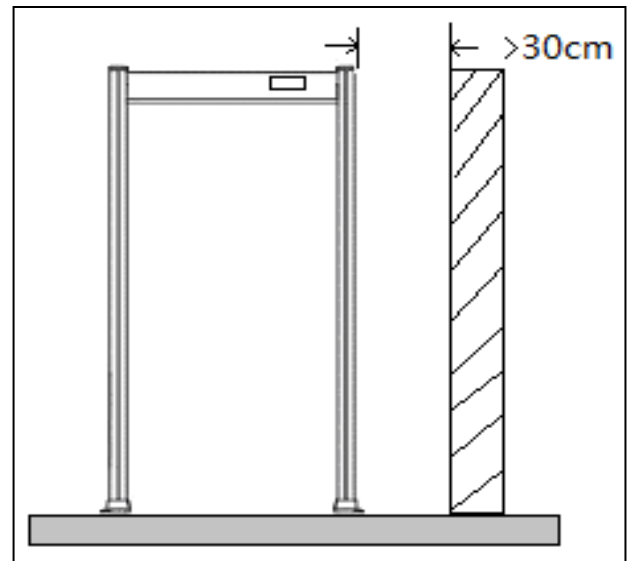

### 2. Movable Metallic Items

Installation near movable items, it should stay away from the detector at least 0.5-2 meters to avoid false alarm. Especially install the detector at factory gate or ground floor. Pls pay attention to the effect of rolling gate, iron security doors, elevators and cars on the detector.

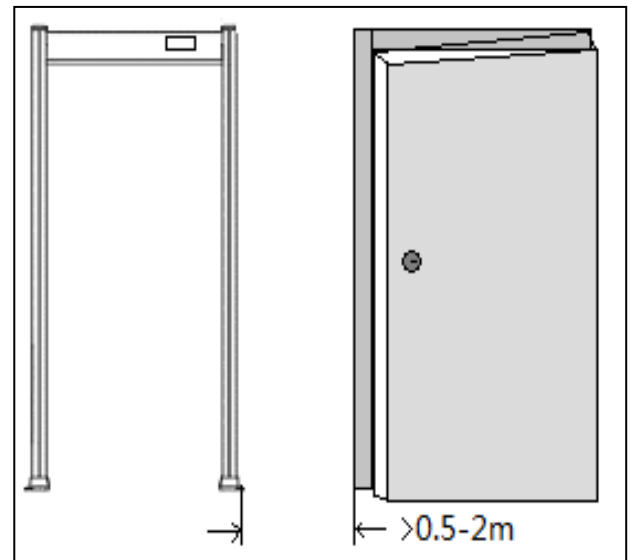

### 3. Vibration effect

The installation ground should be flat and fixed, to prevent vibration. Especially when there is unstable metal articles under the detector, the vibration will cause unnecessary alarm.

#### **4. Electromagnetic Radiation and Electromagnetic Interference**

The detector use bilateral transceiver technology, therefore, any electromagnetic interference sources and electromagnetic radiation source is not allowed to close the detector. The recommend minimum distance is 0.5m to 4 m, and actual distance will depend on environment and sensitivity.

The electromagnetic interference sources and electromagnetic radiation sources are as follows:

Electrical Control Box, Radio Equipment, Interphone, Electronic Computer And

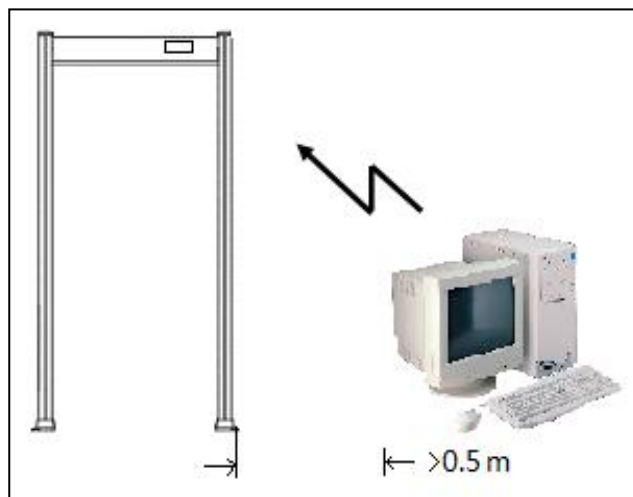

Peripheral Equipment, Video Monitor, High Power Motor, Power Transformer, Ac Power Lines, Thyristor Control Circuit (High Power Switching Power Supply, Inverter Welder), Engine, Motor etc.

#### **5. Tips for working in line**

When installing the detectors in line, the distance between two walk through metal detectors cannot be less than 50cm. Specific distance parameters according to the actual environment and sensitivity level.

#### **6. Can not install the device in windy place**

It would cause false alarm if the detector swing in the wind during working.

## **【PERFORMANCE AND FEATURES】**

- **Multizones zones:** 6 overlapping detection zones for option, bilateral infrared sensor.
- **LED indicator,** pinpoint to detect metal objects, and show the alarm location.
- **Micro Processor Technology:** the scanning electromagnetic wave generated by the microcomputer control circuit, the scanning rate can be precisely controlled.
- **Sensitivity Adjustable:** each detection zone has 100 sensitivity levels (0 ~ 99). Preset metal size, you can exclude the coins, keys, jewelry, belt buckle etc.
- **DSP Technology:** digital signal processing technology and excellent anti-interference capability.
- **Password Protection:** The sensitivity and programing parameters can only be changed by the authorized person with correct password. It's to avoid misoperation
- **Automatically accounting:** 5 digits LED passenger count and alarm count.
- **Harmless to human body:** harmless to heart pacemaker, pregnant women, magnetic floppy disk, recording tapes etc.
- **Power Supply Security:** Fuse inside to prevent from over current.
- **Waterproof Foot Cover:** can be fixed on the ground if necessary
- High density wood material, special technology, rainproof, fireproof and shockproof.
- **Easy to install:** the system is integrated design, just 5 minutes to complete the installation or disassemble.
- **Customized function for option**

**【PARTS】**

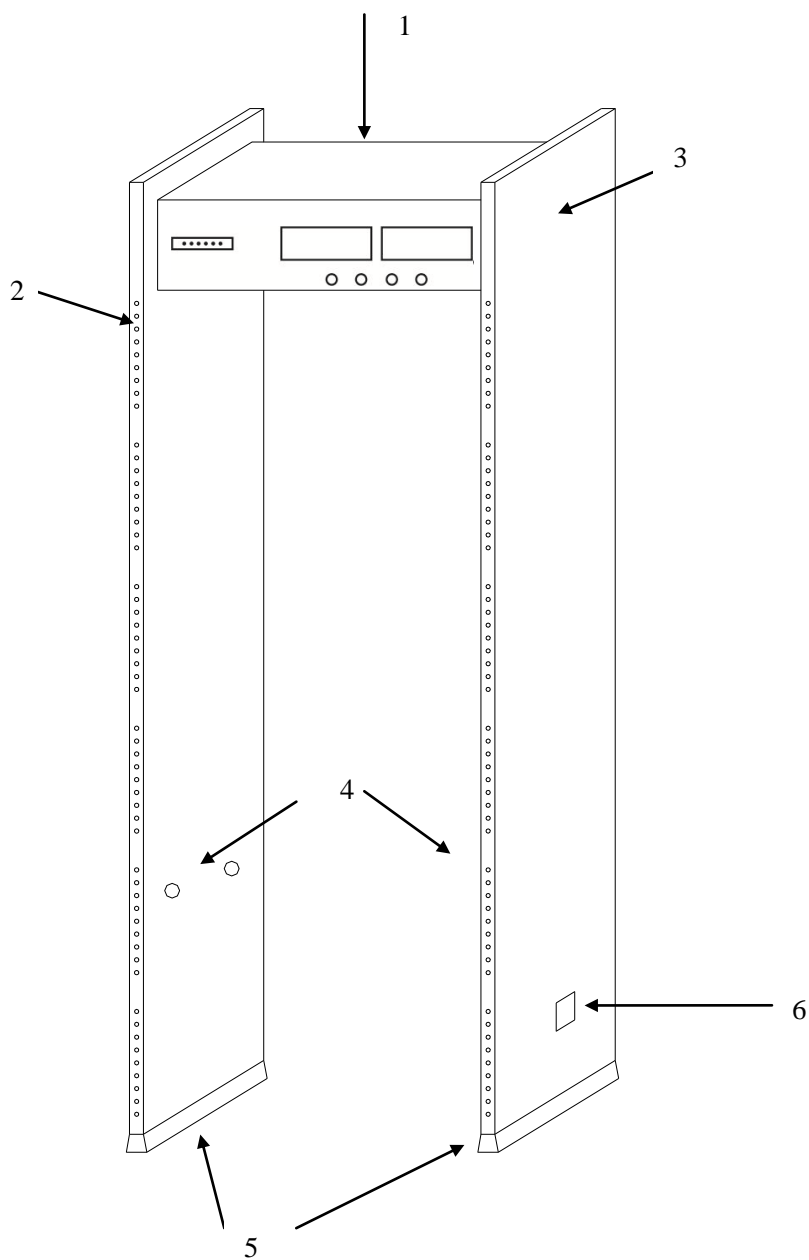

1. Main Control Unit

2. Side LED indicator

3. Side door frame panel

4. Infrared Sensor

5. Waterproof Foot Cover

6. Power supply socket

## 【ASSEMBLING】

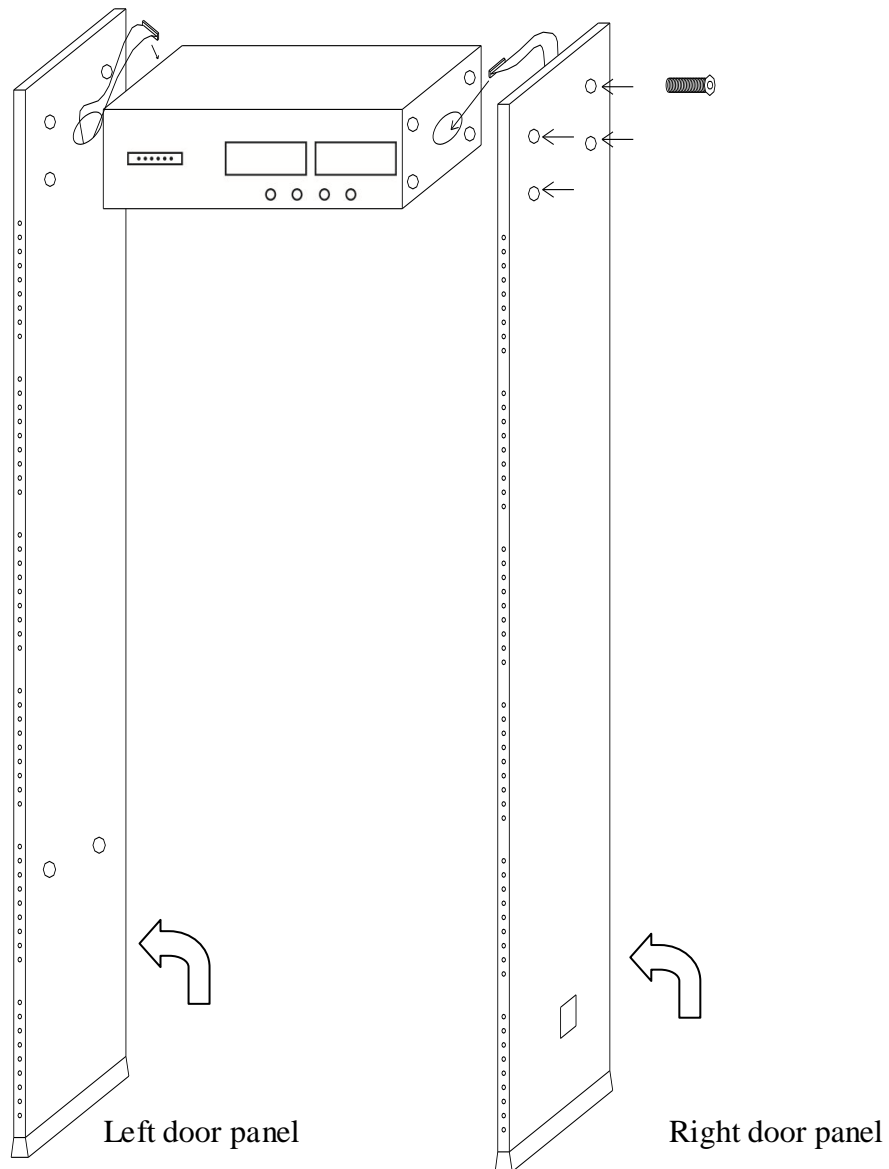

1. Remove the package of control unit and door panel.
2. Put the control unit case and door panels as shown in the picture above, then connect the left and right door panel with the control unit case by bolts and nuts. Tightening screws.
3. Probe line of the left and right door panel tightly inserted into the motherboard corresponding socket respectively.

4. Install the screw on the control unit case cover.
5. Rise up the walk through metal detector to the vertical position and move to the assigned position.
6. Plug power cable

### **【CONTROL PANEL】**

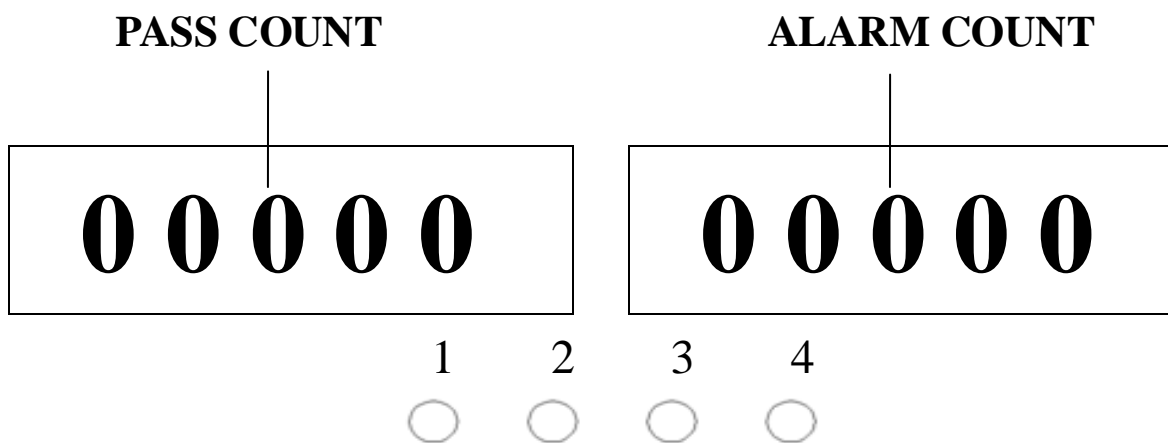

1. ENTER: confirm the data after adjusting, and change the single digit when setting the zone sensitivity level
2. SETUP: Switch to various data, and change the tens digit when setting the zone sensitivity level

If press “SETUP” for 5 seconds, you can adjust the frequency. From frequency 1 to frequency 12 for optional.

3. SELECT: choose each program and increase the numerical value when input password.
4. RESET: reset PASS CNT and ALARM CNT.

After adjusted the zone sensitivity, press RESET to confirm directly.



## 【DETECTION ZONES】

A. LED counter:

Indicate pass count and alarm count

B. Alarm zones display.

There are six unique sets of precise positioning LED evenly distribution on the door panels, means 6 detection zones (from bottom to top is zone 1, zone 2, zone 3, zone 4, zone 5, zone 6). If the metal reaches or exceeds preset value, the red LED alarm. If there are multiple alarm targets, the LED light of each target location would be lighted and with sound alarm.

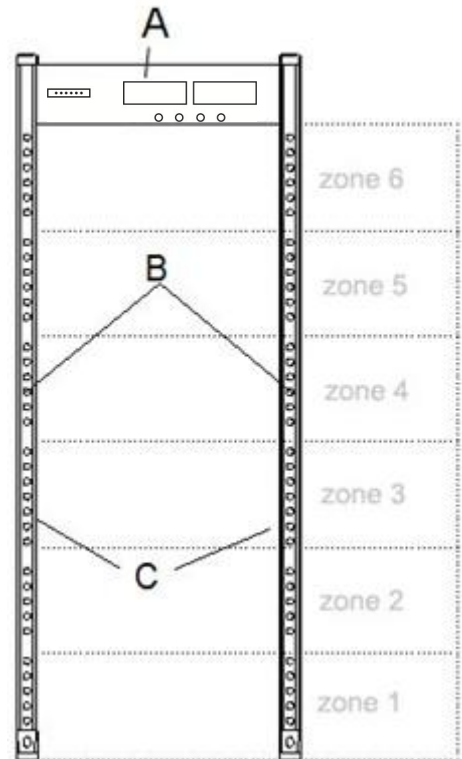

C. Infrared sensor

After connected power supply, the metal detector starts to work. When there is no person or object passes the device, the infrared sensors can effectively stop alarming to avoid false alarm. And accurate count passengers and alarm times.

## 【OPERATION】

1. Press "SELECT", panel displays "12345".

This is the initial password, if you have changed the password, please enter new password.

2. Then press "ENTER", if it shows "00000". (If displayed "00000", it means input the correct password, you can enter the next debugging program; if shown "E0000", means input the wrong password, need to input the correct password again);
3. Once again press "ENTER", it displays "d-01", (meaning: the alarm time is 1 second. 1-3 seconds for option).
4. Press "SELECT", it shows "1- XX" ( "1" on behalf of the zone I, "XX" means the sensitivity value).

You can press "SETUP" to change the tens digit and press "ENTER" to change the single digit.

XX numerical is bigger, the sensitivity is higher.

5. In order press "SELECT", you can enter the next debugging program. It's for zone 2- zone 7.

Zone 7 is overall sensitivity.

6. After adjusted the sensitivity, press "SELECT", it displays "d-01". You can press "SETUP" to change the alarm time. Default is one second.
7. After adjusted alarm time, press "ENTER". Then all the debugging programs have been completed. The device can work normally.
8. The device can automatically count the number of passengers and alarm times. Memory is 99999, press "RESET" to recount.

**Password input:**

1. Press "SELECT", panel displays "12345".
2. Press "SETUP", panel displays "1-345". "-" is for adjustable digit. Continue press "SETUP" to shift "-".
3. Press "SELECT" can increase the number of "-".
4. After input the correct password, press "ENTER", it shows "00000". If shown "E0000", means input the wrong password, need to input the correct password again.
5. Press "ENTER" again, it displays "d-01". Then press "SELECT" to enter the next step.

**Change password:**

1. Press "SELECT", panel displays "12345". If you have changed the password, please enter a password.
2. If you have forgot the password, you can press "SETUP" and "SELECT" to change "E0000" into "88888", then press "ENTER".

Panel displays "00000", press "SELECT" to input the number, then press "SETUP" to shift the digit.

3. After input the password you set, press "ENTER", displays "d-01", press "ENTER" again, the password change is completed.

## **【DETECTION ADJUSTMENT】**

1. The device must be in a stable status to achieve the best detection effect (refer to the "Installation Environment"), to check whether the device in a stable status, the steps as follows:

a. The device is not shaking after power ON for 1 minute.

b. The device would not alarm when the tester did not carry any metal items walk through the detector.

2. Excluding small portable metal objects such as rings, key, belt buckle, shoes and so on, according to the following steps to adjust:

a. Choose a small metal as the sample, such as keys.

b. Increasing the sensitivity, so that when the tester carry the sample and pass through the device, the detector would alarms.

c. Decreasing the sensitivity a little, carry the sample pass through the device again, if it still alarms, once again to reduce the sensitivity, until the device not alarm when the sample passed through.

Note: If you want to decrease the sensitivity in a certain zone, only have to adjust the sensitivity of relative zone. After finished the above adjustment, the metal which smaller than the sample will not alarm, but the metal objects bigger than the sample can be detected accurately.

If need decrease total sensitivity, you can adjust zone 7.

### 3. Traffic regulations:

- a. Draw a waiting line for 50cm away from the device, so that the passengers can line up and pass one by one.
- b. Before the passengers walk through the device, they should remove all the carried metal objects (such as keys, mobile phone, watch, coins, etc.), place on the side of security chute or a table, and pick it up after security checking.
- c. Passengers should line up one by one to pass the device, do not crowd, walk through with normal speed, can not intentionally rush or postponed, and do not crash the door panel.
- d. If the devices alarms when someone pass through, that means there are some metal objects were hidden in his body. The security guard can use a hand-held metal detector accurately detect the hidden position according to the alarm zones.

### **【BRIEF MAINTENANCE】**

#### 1. Infrared sensor can not count:

- a. Check the probe cables whether well connected with the door panels.
- b. Check whether there is some infrared interference beside the device, such as: infrared surveillance system, infrared remote control (when press button), outdoor sunlight, etc.
- c. If not above problems, please replace the Infrared sensor directly.

#### 2. False alarm

After installation, if the device gives false alarms frequently.

- Firstly, check the installation environment. Make sure there is no movable or stationary large metal objects around in 1.5 meters. Otherwise, try to make the device away from the large metal objects. In addition, make sure the installation location with no wind cause shaking.
- Secondly,if the false alarm is not caused by the environment, please reduce the sensitivity of all zones.
- Change the frequency
- Change the installation location

If above 4 steps are useless, pls change a new mainboard to see whether it is working .If works well ,then maybe PCB board problem.If still same, it will be the interference problem. We recommend moving the detetors to another place or changing the installation directions.

## **【PACKING LIST】**

Package should contain the following items:

(1) L side panel	1set	(2) R side panel	1set
(3) Control Unit	1pcs	(4) User manual	1pcs
(5) Power cable	1pcs	(6) Screws	8pcs
(7) Hex wrench	1pcs	(8) Key	2pcs

## 【TECHNICAL PARAMETERS】

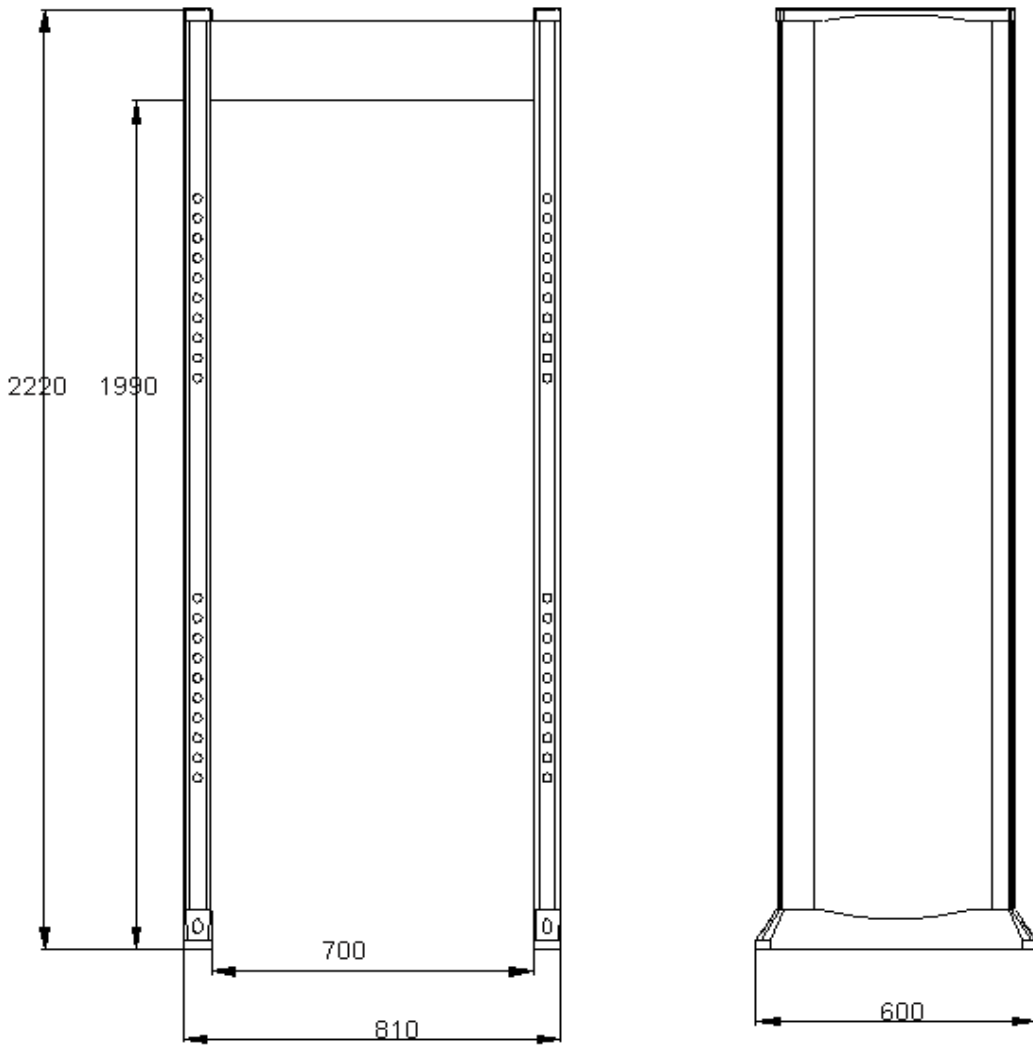

Input voltage: 100-240V, 50/60Hz

Power: <30W

Gross weight: 65KG

Working temperature: -25°C ~ 55°C

Sensitivity: 100 level adjustable

Alarm: Visible and audible alarm

Inner Dimensions: 2000mm (H) x 700mm (W) x 500mm (D)

External Dimensions: 2220mm (H) x 810mm (W) x 600mm (D)

(Above dimensions just for reference , please confirm the size with real products)

**【WARRANTY CARD】**

1. Please keep this card with reasonableness, and show it when maintaining it.
2. This card will be invalid if without the signature or stamp of the designated dealer.

Model Number	
ID	
Date Acquisition	
User Name	
Address	
User's Phone Number	
User's Fax Number	

Date of Maintenance	Record of Maintenance	Maintainer